



Proposal Submitted By:

Contractor's Name

Contractor's Address

City

State

Zip Code

STATE OF ILLINOIS

Local Public Agency

County

Section Number

Street Name/Road Name

Type of Funds

Material proposal Deliver and Install Proposal Plans

For a County and Road District Project

Submitted/Approved

Highway Commissioner Signature & Date

Submitted/Approved

County Engineer/Superintendent of Highways Signature & Date

For a Municipal Project

Submitted/Approved/Passed

Signature & Date

Official Title

Department of Transportation

Released for bid based on limited review

Regional Engineer Signature & Date

Note: All proposal documents, including Proposal Guaranty Checks or Proposal Bid Bonds, should be stapled together to prevent loss when bids are processed.

Local Public Agency Sunbury Road District	County Livingston	Section Number 24-28121-00-AS
--	----------------------	----------------------------------

NOTICE TO BIDDERS

Sealed proposals for the project described below will be received at the office of County Engineer
 1705 South Manlove Street, Pontiac, Illinois 61764 Name of Office
 until 10:00 AM on 05/30/24
Address Time Date

1. Plans and proposal forms will be available in the office of
 Livingston County Highway Department
 1705 South Manlove Street, Pontiac, Illinois 61764

2. Prequalification
 If checked, the 2 low bidders must file within 24 hours after the letting an "Affidavit of Availability" (Form BC 57) in duplicate, showing all uncompleted contracts awarded to them and all low bids pending award for Federal, State, County, Municipal and private work. One original shall be filed with the Awarding Authority and one original with the IDOT District Office.
3. The Awarding Authority reserves the right to waive technicalities and to reject any or all proposals as provided in BLRS Special Provision for Bidding Requirements and Conditions for Material/Deliver and Install Proposals.
4. A proposal guaranty in the proper amount, as specified in the BLRS Special Provision for Bidding Requirements and Conditions for Material/Deliver and Install Proposals, will be required. See the attached Special Provisions for specific instructions for proposal guaranty for this proposal packet.
5. The successful bidder at the time of execution of the contract will be required to deposit a contract bond or proposal guaranty as provided for in the special provisions. Failure on the part of the contractor to deliver the material within the time specified or to do the work specified herein will be considered just cause to forfeit his surety as provided in Article 108.10 of the Standard Specifications.
6. Proposals shall be submitted on forms furnished by the Awarding Authority and shall be enclosed in an envelope endorsed "Material Proposal, Section 24-28121-00-AS".

By Order of Awarding Authority Highway Committee / Livingston County Board	County Engineer/Superintendent of Highways/ Municipal Clerk Clay A. Metcalf	Date 04/04/24
--	---	------------------

Material Proposal or Deliver & Install Proposal

To
 Awarding Authority
 Highway Committee / Livingston County Board

Awarding Authority Address 1705 South Manlove Street	City Pontiac	State IL	Zip Code 61764
---	-----------------	-------------	-------------------

If this bid is accepted within 45 days from the date of opening, the undersigned agrees to furnish or to deliver & install any or all of the materials, at the quoted unit prices, subject to the following:

- It is understood and agreed that the "Standard Specifications for Road and Bridge Construction", adopted 01/01/22 and the "Supplemental Specifications and Recurring Special Provisions", adopted 01/01/24, prepared by the Department of Transportation, shall govern insofar as they may be applied and insofar as they do not conflict with the special provision and supplemental specifications attached hereto.
- It is understood that quantities listed are approximate only and that they may be increased or decrease as may be needed to properly complete the improvement within its present limits or extensions thereto, at the unit prices stated and that bids will be compared on the basis of total price bid for each group.
- Delivery in total or partial shipments as ordered shall be made within the time specified in the special provisions or by the acceptance at the point and in the manner specified in the "Schedule of Prices". If delivery on the job site is specified, it shall mean any place or paces on the road designed by the awarding authority or its authorized representative.
- The contractor and/or local public agency performing the actual material placement operations shall be responsible for providing work zone traffic control, unless otherwise specified in this proposal. Such devices shall meet the requirements of and be installed in accordance with applicable provisions of the "Illinois Manual on Uniform Traffic Control Devices" and any referenced Illinois Highway Standards.

Local Public Agency

County

Section Number

Sunbury Road District

Livingston

24-28121-00-AS

- 5. Each pay item should have a unit price and a total price. If no total price is shown or if there is a discrepancy between the product of the unit price multiplied by the quantity, the unit price shall govern. If a unit price is omitted, the total price will be divided by the quantity in order to establish a unit price. A bid will be declared unacceptable if neither a unit price nor a total price is shown.
- 6. A proposal guaranty in the proper amount, as specified in BLRS Special Provision for Bidding Requirements and Conditions for Contract Proposals, will be required. The proposal guaranty as specified in the special provisions is attached.

If a bid bond is allowed or required, Department form BLR 12230 or a proposal guaranty check, complying with the specifications, made payable to: _____ Treasurer of Livingston County

The amount of the check is _____ (_____).

Attach Cashier's Check or Certified Check Here

In the event that one proposal guaranty check is intended to cover two or more bid proposals, the amount must be equal to the sum of the proposal guaranties which would be required for each individual bid proposal. If the proposal guaranty check is place in another bid proposal, state below where it may be found.

The proposal guaranty check will be found in the bid proposal for: Section Number _____).

Discounts will be allowed for payment as follows: _____ calendar days _____ calendar days

Discounts will not be considered in determining the low bidder

Bidder

By

Title

Address

City

State

Zip Code

The following Special Provisions supplement the "Standard Specifications for the Road and Bridge Construction", Adopted January 1, 2022, the latest edition of the "Manual on Uniform Traffic Control Devices for Streets and Highway", and the "Manual of Test Procedures of Materials" in effect on the date of invitation of bids, and the Supplemental Specification and Recurring Special Provisions indicated on the Check Sheet included here in which apply to and govern the construction of Section 24-28121-00-AS MFT & LOCAL FUNDS, and in case of conflict with any part, or parts, of said Specifications, said Special Provisions shall take precedence and shall govern.

1. The work to be performed under this contract includes furnishing and delivering the materials to jobsite through an approved Spreader Box.
2. **Grade of Material:** The surface material shall conform to Grade No. CA- 6 or CA-10 of the Standard Specifications adopted January 1, 2022.
3. **Engineer:** The Engineer shall be the County Engineer or his authorized representative. All materials shall be of a quality approved by the Engineer and his word shall be final in approving or rejecting any or all material.
4. It is understood and agreed that payments will be made on the basis of 90% of the total amount of material furnished every month. Each truckload of material shall be weighed to the nearest 100 pounds. Final payment shall be based on the total tons of material as determined by the Engineer.
5. The successful bidder shall begin delivery immediately following the approval of award and continue at a minimum rate of 500 tons per day until completed, unless other arrangements are made with the Highway Commissioner.
6. The Contractor shall notify the Engineer at least twenty-four (24) hours in advance of starting any work covered in this proposal.
7. The proposal guaranty shall be a certified check or a bank cashier's check made payable to the **Treasurer of Livingston County**.
8. The undersigned Contractor agrees to complete the work on or before August 1, 2024.
9. Since the aggregate (CA-6 or CA-10) furnished under this contract will become the base for a future bituminous surface treatment the following additional requirements must be met:
 1. The plasticity index shall not exceed 6 if crushed stone is furnished.
 2. The plasticity index shall be between 2 and 6 if gravel is furnished.

10. If at the time the aggregate is weighed, it contains more than seven (7) per cent of absorbed and free moisture by weight, a deduction for the amount of moisture in excess of this amount shall be made in determining the pay quantity, except that any water added for compaction shall not be included in the pay quantity.
11. The surface material to be delivered on the road shall be placed in 3 lifts by means of an approved spreader box, unless tailgating is approved by the Highway Commissioner. The Road District will provide necessary personnel to attend the spreader box.
12. The roadbed will be prepared and kept in shape ahead of the spreader box by Road District Day Labor. The Road District will also blade the material after it has been spread through the spreader box.
13. All traffic control shall be the responsibility of the Road District.

SUMMARY OF LENGTH

SHEET NO. 1 OF 1

STATION TO STATION	WIDTH		LENGTH		EQUATIONS		TOTAL LENGTH		OMISSIONS		NET LENGTH		SQUARE YARDS TO BE CONSTRUCTED					
	FEET	FEET	FEET	FEET	STA to STA	FEET	FEET	FEET	STA to STA	FEET	FEET	FEET	GRAN. BASE TON	BASE PREP. SQ YD	PRIME GAL.	C & S TONS	TOTAL SQ YDS	
Loc. # 1																		
0+22 to 53+15	20'	5,293'			(8.0" Compacted) (12.8" Loose) 98.8 T/C'		5,293'					5,293'	5,230				11,762	
					Mailbox Turnouts				(0)				0				0	
					Private Entrances				(3)				99				195	
					Intersections				(0)				0				0	
TOTALS												5,293'	5,329				11,957	

BDE SPECIAL PROVISIONS
For the April 26 and June 14, 2024 Lettings

The following special provisions indicated by a "check mark" are applicable to this contract and will be included by the Project Coordination and Implementation Section of the Bureau of Design & Environment (BDE).

File Name	#		Special Provision Title	Effective	Revised
	80099	1	<input type="checkbox"/> Accessible Pedestrian Signals (APS)	April 1, 2003	Jan. 1, 2022
	80274	2	<input type="checkbox"/> Aggregate Subgrade Improvement	April 1, 2012	April 1, 2022
	80192	3	<input type="checkbox"/> Automated Flagger Assistance Devices	Jan. 1, 2008	April 1, 2023
	80173	4	<input type="checkbox"/> Bituminous Materials Cost Adjustments	Nov. 2, 2006	Aug. 1, 2017
	80426	5	<input type="checkbox"/> Bituminous Surface Treatment with Fog Seal	Jan. 1, 2020	Jan. 1, 2022
*	80241	6	<input type="checkbox"/> Bridge Demolition Debris	July 1, 2009	
*	50531	7	<input type="checkbox"/> Building Removal	Sept. 1, 1990	Aug. 1, 2022
*	50261	8	<input type="checkbox"/> Building Removal with Asbestos Abatement	Sept. 1, 1990	Aug. 1, 2022
	80449	9	<input type="checkbox"/> Cement, Type II	Aug. 1, 2023	
	80384	10	<input type="checkbox"/> Compensable Delay Costs	June 2, 2017	April 1, 2019
*	80198	11	<input type="checkbox"/> Completion Date (via calendar days)	April 1, 2008	
*	80199	12	<input type="checkbox"/> Completion Date (via calendar days) Plus Working Days	April 1, 2008	
	80453	13	<input type="checkbox"/> Concrete Sealer	Nov. 1, 2023	
	80261	14	<input type="checkbox"/> Construction Air Quality – Diesel Retrofit	June 1, 2010	Nov. 1, 2014
	80434	15	<input type="checkbox"/> Corrugated Plastic Pipe (Culvert and Storm Sewer)	Jan. 1, 2021	
*	80029	16	<input type="checkbox"/> Disadvantaged Business Enterprise Participation	Sept. 1, 2000	Mar. 2, 2019
	80229	17	<input type="checkbox"/> Fuel Cost Adjustment	April 1, 2009	Aug. 1, 2017
	80452	18	<input type="checkbox"/> Full Lane Sealant Waterproofing System	Nov. 1, 2023	
	80447	19	<input type="checkbox"/> Grading and Shaping Ditches	Jan. 1, 2023	
	80433	20	<input type="checkbox"/> Green Preformed Thermoplastic Pavement Markings	Jan. 1, 2021	Jan. 1, 2022
	80443	21	<input type="checkbox"/> High Tension Cable Median Barrier Removal	April 1, 2022	
	80456	22	<input type="checkbox"/> Hot-Mix Asphalt	Jan. 1, 2024	
	80446	23	<input type="checkbox"/> Hot-Mix Asphalt - Longitudinal Joint Sealant	Nov. 1, 2022	Aug. 1, 2023
	80438	24	<input type="checkbox"/> Illinois Works Apprenticeship Initiative – State Funded Contracts	June 2, 2021	April 2, 2024
	80045	25	<input type="checkbox"/> Material Transfer Device	June 15, 1999	Jan. 1, 2022
	80450	26	<input type="checkbox"/> Mechanically Stabilized Earth Retaining Walls	Aug. 1, 2023	
	80441	27	<input type="checkbox"/> Performance Graded Asphalt Binder	Jan. 1, 2023	
	80451	28	<input type="checkbox"/> Portland Cement Concrete	Aug. 1, 2023	
*	34261	29	<input type="checkbox"/> Railroad Protective Liability Insurance	Dec. 1, 1986	Jan. 1, 2022
	80455	30	<input type="checkbox"/> Removal and Disposal of Regulated Substances	Jan. 1, 2024	April 1, 2024
	80445	31	<input type="checkbox"/> Seeding	Nov. 1, 2022	
	80457	32	<input type="checkbox"/> Short Term and Temporary Pavement Markings	April 1, 2024	
	80448	33	<input type="checkbox"/> Source of Supply and Quality Requirements	Jan. 2, 2023	
	80340	34	<input type="checkbox"/> Speed Display Trailer	April 2, 2014	Jan. 1, 2022
	80127	35	<input type="checkbox"/> Steel Cost Adjustment	April 2, 2004	Jan. 1, 2022
	80397	36	<input type="checkbox"/> Subcontractor and DBE Payment Reporting	April 2, 2018	
	80391	37	<input type="checkbox"/> Subcontractor Mobilization Payments	Nov. 2, 2017	April 1, 2019
	80437	38	<input type="checkbox"/> Submission of Payroll Records	April 1, 2021	Nov. 2, 2023
	80435	39	<input type="checkbox"/> Surface Testing of Pavements – IRI	Jan. 1, 2021	Jan. 1, 2023
	80410	40	<input type="checkbox"/> Traffic Spotters	Jan. 1, 2019	
*	20338	41	<input type="checkbox"/> Training Special Provisions	Oct. 15, 1975	Sept. 2, 2021
	80429	42	<input type="checkbox"/> Ultra-Thin Bonded Wearing Course	April 1, 2020	Jan. 1, 2022
	80439	43	<input type="checkbox"/> Vehicle and Equipment Warning Lights	Nov. 1, 2021	Nov. 1, 2022
	80302	44	<input type="checkbox"/> Weekly DBE Trucking Reports	June 2, 2012	Nov. 1, 2021
	80454	45	<input type="checkbox"/> Wood Sign Support	Nov. 1, 2023	
	80427	46	<input type="checkbox"/> Work Zone Traffic Control Devices	Mar. 2, 2020	
*	80071	47	<input type="checkbox"/> Working Days	Jan. 1, 2002	

Highlighted items indicate a new or revised special provision for the letting.

An * indicates the special provision requires additional information from the designer, which needs to be submitted separately. The Project Coordination and Implementation Section will then include the information in the applicable special provision.

The following special provisions are in the 2024 Supplemental Specifications and Recurring Special Provisions.

<u>File Name</u>	<u>Special Provision Title</u>	<u>New Location(s)</u>	<u>Effective</u>	<u>Revised</u>
80436	Blended Finely Divided Minerals	Articles 1010.01 & 1010.06	April 1, 2021	
80440	Waterproofing Membrane System	Article 1061.05	Nov. 1, 2021	



Local Public Agency

Sunbury Road District

County

Livingston

Section Number

24-28121-00-AS

Check this box for lettings prior to 01/01/2024.

The Following Recurring Special Provisions Indicated By An "X" Are Applicable To This Contract And Are Included By Reference:

Recurring Special Provisions

<u>Check Sheet #</u>		<u>Page No.</u>
1	<input type="checkbox"/> Additional State Requirements for Federal-Aid Construction Contracts	59
2	<input type="checkbox"/> Subletting of Contracts (Federal-Aid Contracts)	62
3	<input type="checkbox"/> EEO	63
4	<input type="checkbox"/> Specific EEO Responsibilities Non Federal-Aid Contracts	73
5	<input type="checkbox"/> Required Provisions - State Contracts	78
6	<input type="checkbox"/> Asbestos Bearing Pad Removal	84
7	<input type="checkbox"/> Asbestos Waterproofing Membrane and Asbestos HMA Surface Removal	85
8	<input type="checkbox"/> Temporary Stream Crossings and In-Stream Work Pads	86
9	<input type="checkbox"/> Construction Layout Stakes	87
10	<input type="checkbox"/> Use of Geotextile Fabric for Railroad Crossing	90
11	<input type="checkbox"/> Subsealing of Concrete Pavements	92
12	<input type="checkbox"/> Hot-Mix Asphalt Surface Correction	96
13	<input type="checkbox"/> Pavement and Shoulder Resurfacing	98
14	<input type="checkbox"/> Patching with Hot-Mix Asphalt Overlay Removal	99
15	<input type="checkbox"/> Polymer Concrete	101
16	<input type="checkbox"/> Reserved	103
17	<input type="checkbox"/> Bicycle Racks	104
18	<input type="checkbox"/> Temporary Portable Bridge Traffic Signals	106
19	<input type="checkbox"/> Nighttime Inspection of Roadway Lighting	108
20	<input type="checkbox"/> English Substitution of Metric Bolts	109
21	<input type="checkbox"/> Calcium Chloride Accelerator for Portland Cement Concrete	110
22	<input type="checkbox"/> Quality Control of Concrete Mixtures at the Plant	111
23	<input type="checkbox"/> Quality Control/Quality Assurance of Concrete Mixtures	119
24	<input type="checkbox"/> Reserved	135
25	<input type="checkbox"/> Reserved	136
26	<input type="checkbox"/> Temporary Raised Pavement Markers	137
27	<input type="checkbox"/> Restoring Bridge Approach Pavements Using High-Density Foam	138
28	<input type="checkbox"/> Portland Cement Concrete Inlay or Overlay	141
29	<input type="checkbox"/> Portland Cement Concrete Partial Depth Hot-Mix Asphalt Patching	145
30	<input type="checkbox"/> Longitudinal Joint and Crack Patching	148
31	<input type="checkbox"/> Concrete Mix Design - Department Provided	150
32	<input type="checkbox"/> Station Numbers in Pavements or Overlays	151

Local Public Agency

County

Section Number

Sunbury Road District

Livingston

24-28121-00-AS

The Following Local Roads And Streets Recurring Special Provisions Indicated By An "X" Are Applicable To This Contract And Are Included By Reference:

Local Roads And Streets Recurring Special Provisions

<u>Check Sheet #</u>		<u>Page No.</u>
LRS 1	Reserved	153
LRS 2	<input type="checkbox"/> Furnished Excavation	154
LRS 3	<input type="checkbox"/> Work Zone Traffic Control Surveillance	155
LRS 4	<input type="checkbox"/> Flaggers in Work Zones	156
LRS 5	<input checked="" type="checkbox"/> Contract Claims	157
LRS 6	<input type="checkbox"/> Bidding Requirements and Conditions for Contract Proposals	158
LRS 7	<input checked="" type="checkbox"/> Bidding Requirements and Conditions for Material Proposals	164
LRS 8	Reserved	170
LRS 9	<input type="checkbox"/> Bituminous Surface Treatments	171
LRS 10	Reserved	175
LRS 11	<input checked="" type="checkbox"/> Employment Practices	176
LRS 12	<input type="checkbox"/> Wages of Employees on Public Works	178
LRS 13	<input checked="" type="checkbox"/> Selection of Labor	180
LRS 14	<input type="checkbox"/> Paving Brick and Concrete Paver Pavements and Sidewalks	181
LRS 15	<input checked="" type="checkbox"/> Partial Payments	184
LRS 16	<input type="checkbox"/> Protests on Local Lettings	185
LRS 17	<input type="checkbox"/> Substance Abuse Prevention Program	186
LRS 18	<input type="checkbox"/> Multigrade Cold Mix Asphalt	187
LRS 19	<input type="checkbox"/> Reflective Crack Control Treatment	188

State of Illinois
Department of Transportation
Bureau of Local Roads and Streets

SPECIAL PROVISION
FOR
CONTRACT CLAIMS

Effective: January 1, 2002

Revised: January 1, 2007

Revise the second sentence of subparagraph (a) of Article 109.09 of the Standard Specifications to read:

"All claims shall be submitted to the Engineer."

Revise subparagraph (e) of Article 109.09 of the Standard Specifications to read:

"(e) Procedure. All Claims shall be submitted to the Engineer. The Engineer will consider all information submitted with the claim. Claims not conforming to this Article will be returned without consideration. The Engineer may schedule a claim presentation meeting if, in the Engineer's judgment, such a meeting would aid in resolution of the claim, otherwise a decision will be based on the claim documentation submitted. A final decision will be rendered within 90 days of receipt of the claim.

Full compliance by the Contractor with the provisions specified in this Article is a contractual condition precedent to the Contractor's right to seek relief in the Court of Claims. The Engineer's written decision shall be the final administrative action of the Department. Unless the Contractor files a claim for adjudication by the Court of Claims within 60 days after the date of the written decision, the failure to file shall constitute a release and waiver of the claim."

CHECK SHEET #LRS7

State of Illinois
Department of Transportation
Bureau of Local Roads and Streets

**SPECIAL PROVISION
FOR
BIDDING REQUIREMENTS AND CONDITIONS FOR MATERIAL PROPOSALS**

Effective: January 1, 2002

Revised: January 1, 2013

Replace Article 102.01 of the Standard Specifications with the following:

Prequalification of Bidders. When prequalification is required and the awarding authority for contract construction work is the County Board of a County, the Council, the City Council, or the President and Board of Trustees of a city, village, or town, each prospective bidder, in evidence of competence, shall furnish the awarding authority as a prerequisite to the release of proposal forms by the awarding authority, a certified or photostatic copy of a "Certificate of Eligibility" issued by the Department of Transportation, in accordance with the Department's "Prequalification Manual".

The two low bidders must file, within 24 hours after the letting, a sworn affidavit in triplicate, showing all uncompleted contracts awarded to them and all low bids pending award for Federal, State, County, Municipal and private work, using the blank form made available for this affidavit. One copy shall be filed with the awarding authority and two copies with the District office.

Issuance of Proposal Forms. The Awarding Authority reserves the right to refuse to issue a proposal form for bidding purposes for any of the following reasons:

- (a) Lack of competency and adequate machinery, plant, and other equipment, as revealed by the financial statement and experience questionnaires required in prequalification procedures.
- (b) Uncompleted work which, in the judgment of the Awarding Authority, might hinder or prevent the prompt completion of additional work awarded.
- (c) False information provided on a bidder's "Affidavit of Availability".
- (d) Failure to pay, or satisfactorily settle, all bills due for labor and material on former contracts in force at the time of issuance of proposal forms.
- (e) Failure to comply with any prequalification regulations of the Department.
- (f) Default under previous contracts.
- (g) Unsatisfactory performance record as shown by past work for the Awarding Authority, judged from the standpoint of workmanship and progress.
- (h) When the Contractor is suspended from eligibility to bid at a public letting where the contract is awarded by, or requires approval of, the Department.

- (i) When any agent, servant, or employee of the prospective bidder currently serves as a member, employee, or agent of a governmental body that is financially involved in the proposal work.
- (j) When any agent, servant, or employee of the perspective bidder has participated in the preparation of plans or specifications for the proposed work.

Interpretation of Quantities in the Bid Schedule. The quantities appearing in the bid schedule are approximate and are prepared for the comparison of bids. Payment to the Contractor will be made only for the actual quantities of work performed and accepted or materials furnished according to the contract. The scheduled quantities of work to be done and materials to be furnished may be increased, decreased or omitted as hereinafter provided.

Examination of Material Proposal, Specifications, Special Provisions, and Site of Work. The bidder shall, before submitting a bid, carefully examine the provisions of the proposal. The bidder shall inspect in detail the site of the proposed work, investigate and become familiar with all the local conditions affecting the work and fully acquaint themselves with the detailed requirements of the work. Submission of a bid shall be a conclusive assurance and warranty the bidder has made these examinations and the bidder understands all requirements for the performance of the work. If his/her bid is accepted, the bidder will be responsible for all errors in the proposal resulting from his/her failure or neglect to comply with these instructions. The Awarding Authority will, in no case, be responsible for any costs, expenses, losses, or change in anticipated profits resulting from such failure or neglect of the bidder to make these examinations.

The bidder shall take no advantage of any error or omission in the proposal. Any prospective bidder who desires an explanation or interpretation of the specification, or any of the documents, shall request such in writing from the Awarding Authority, in sufficient time to allow a written reply by the Awarding Authority that can reach all prospective bidders before the submission of their bids. Any reply given a prospective bidder concerning any of the documents and specifications will be furnished to all prospective bidders in the form determined by the Awarding Authority including, but not limited to, an addendum, if the information is deemed by the Awarding Authority to be necessary in submitting bids or if the Awarding Authority concludes the information would aid competition. Oral explanations, interpretations or instructions given before the submission of bids unless at a prebid conference will not be binding on the Awarding Authority.

Preparation of the Proposal. Bidders shall submit their proposals on the form furnished by the Awarding Authority. The proposal shall be executed properly, and bids shall be made for all items indicated in the proposal form, except when alternate bids are asked, a bid on more than one alternate for each item is not required, unless otherwise provided. The bidder shall indicate in figures, a unit price for each of the separate items called for in the proposal form; the bidder shall show the products of the respective quantities and unit prices in the column provided for that purpose, and the gross sum shown in the place indicated in the proposal form shall be the summation of said products. All writing shall be with ink or typewriter, except the signature of the bidder which shall be written in ink.

CHECK SHEET #LRS7

When prequalification is required, the proposal form shall be submitted by an authorized bidder in the same name and style as shown on the "Contractor's Statement of Experience and Financial Condition" used for prequalification and shall be submitted in like manner.

Rejection of Proposals. The Awarding Authority reserves the right to reject any proposal for any of the conditions in "Issuance of Proposal Forms" or for any of the following reasons:

- (a) More than one proposal for the same work from an individual, firm, partnership, or corporation under the same name or different names.
- (b) Evidence of collusion among bidders.
- (c) Unbalanced proposals in which the bid prices for some items are, in the judgment of the Awarding Authority, out of proportion to the bid prices for other items.
- (d) If the proposal does not contain a unit price for each pay item listed, except in the case of authorized alternate pay items or lump sum pay items.
- (e) If the proposal form is other than that furnished by the Awarding Authority; or if the form is altered or any part thereof is detached.
- (f) If there are omissions, erasures, alterations, unauthorized additions, conditional or alternate bids, or irregularities of any kind which may tend to make the proposal incomplete, indefinite or ambiguous as to its meaning.
- (g) If the bidder adds any provisions reserving the right to accept or reject an award, or to enter into a contract pursuant to an award.
- (i) If the proposal is not accompanied by the proper proposal guaranty.
- (i) If the proposal is prepared with other than ink or typewriter, or otherwise fails to meet the requirements of the above "Preparation of Proposal" section.

Proposal Guaranty. Each proposal shall be accompanied by a bid bond on the Department form contained in the proposal, executed by a corporate surety company satisfactory to the Awarding Authority, by a bank cashier's check or a properly certified check for not less than five percent of the amount bid, or for the amount specified in the following schedule:

CHECK SHEET #LRS7

<u>Amount Bid</u>		<u>Proposal Guaranty</u>
Up to	\$5,000	\$150
>\$5,000	\$10,000	\$300
>\$10,000	\$50,000	\$1,000
>\$50,000	\$100,000	\$3,000
>\$100,000	\$150,000	\$5,000
>\$150,000	\$250,000	\$7,500
>\$250,000	\$500,000	\$12,500
>\$500,000	\$1,000,000	\$25,000
>\$1,000,000	\$1,500,000	\$50,000
>\$1,500,000	\$2,000,000	\$75,000
>\$2,000,000	\$3,000,000	\$100,000
>\$3,000,000	\$5,000,000	\$150,000
>\$5,000,000	\$7,500,000	\$250,000
>\$7,500,000	\$10,000,000	\$400,000
>\$10,000,000	\$15,000,000	\$500,000
>\$15,000,000	\$20,000,000	\$600,000
>\$20,000,000	\$25,000,000	\$700,000
>\$25,000,000	\$30,000,000	\$800,000
>\$30,000,000	\$35,000,000	\$900,000
Over	\$35,000,000	\$1,000,000

In the event that one proposal guaranty check is intended to cover two or more proposals, the amount must equal to the sum of the proposal guaranties which would be required for each individual proposal.

Bank cashier's checks or properly certified checks accompanying proposals shall be made payable to the County Treasurer, when a County is the awarding authority; or the City, Village, or Town Treasurer, when a city, village, or town is the awarding authority.

If this proposal contains various groups and the bidder has the option of bidding on one or several groups, the bidder may provide a separate proposal guaranty for each group or combination of groups in lieu of a single proposal guaranty to cover the amount bid for the entire proposal. Each proposal guaranty shall identify the groups covered by the individual proposal guaranty. In the event that one proposal guaranty check is intended to cover two or more groups, the amount must be equal to the sum of the proposal guaranties which would be required for each individual group.

The proposal guaranty checks of all, except the two lowest responsible, will be returned promptly after the proposals have been checked, tabulated, and the relation of the proposals established. Proposal guaranty checks of the two lowest bidders will be returned as soon as the contract and contract bond of the successful bidder have been properly executed and approved. If a contract bond is not required, the proposal guaranty check will be held in lieu thereof. Bid bonds will not be returned.

The awarding authority may deny the use of a bid bond as a proposal guaranty but may not further restrict the proposal guaranty. The Notice of Material Letting will state whether a bid bond is allowed.

CHECK SHEET #LRS7

Delivery of Proposals. If a special envelope is supplied by the Awarding Authority, each proposal should be submitted in that envelope furnished by the Awarding Authority and the blank spaces on the envelope shall be filled in correctly to clearly indicate its contents. When an envelope other than the special one furnished by the Awarding Authority is used, it shall be marked to clearly indicate its contents. When sent by mail, the sealed proposal shall be addressed to the Awarding Authority at the address and in care of the official in whose office the bids are to be received. All proposals shall be filed prior to the time and at the place specified in the Notice to Bidders. Proposals received after the time specified will be returned to the bidder unopened.

Withdrawal of Proposals. Permission will be given a bidder to withdraw a proposal if the bidder makes the request in writing or in person before the time for opening proposals.

Public Opening of Proposals. Proposals will be opened and read publicly at the time and place specified in the Notice to Bidders. Bidders, their authorized agents and other interested parties are invited to be present.

Consideration of Proposals. After the proposals are opened and read, they will be compared on the basis of the summation of the products of the quantities shown in the bid schedule by the unit bid prices. In the event of a discrepancy between unit bid prices and extensions, the unit bid price shall govern. In awarding the supply of materials, the Awarding Authority will, in addition to considering the amounts stated in the proposals, take into consideration the responsibility of the various bidders as determined from a study of the data required under "Prequalification of Bidders", and from other investigations which it may elect to make.

The right is reserved to reject any or all proposals, to waive technicalities or to advertise for new proposals, if in the judgment of the Awarding Authority, the best interests of the Awarding Authority will be promoted thereby.

Acceptance of Proposal to Furnish Material. The award will be made within 45 calendar days after the opening of proposals to the lowest responsible and qualified bidder whose proposal complies with all the requirements prescribed. The successful bidder will be notified by letter of intent that his/her bid has been accepted, and subject to the following conditions, the bidder will be the Contractor or Supplier.

An acceptance of proposal to furnish materials executed by the Awarding Authority is required before the Awarding Authority is bound. An award may be cancelled any time by the Awarding Authority prior to execution in order to protect the public interest and integrity of the bidding process or for any other reason if, in the judgment of the Awarding Authority, the best interests of the Awarding Authority will be promoted thereby.

If a material proposal is not awarded within 45 days after the opening of proposals, bidders may file a written request with the Awarding Authority for the withdrawal of their bid, and the Awarding Authority will permit such withdrawal.

Requirement of Contract Bond. If the Awarding Authority requires a Contract Bond, the Contractor or Supplier shall furnish the Awarding Authority a performance and payment bond with good and sufficient sureties in the full amount of the award as

CHECK SHEET #LRS7

the penal sum. The surety shall be acceptable to the Awarding Authority, shall waive notice of any changes and extensions of time, and shall submit its bond on the form furnished by the Awarding Authority.

The contract bond shall be returned within 15 days after the notice of award. Failure of the successful bidder to execute and file acceptable bonds within 15 days after the notice of award has been mailed to the bidder shall be just cause for the cancellation of the award and the forfeiture of the proposal guaranty which shall become the property of the Awarding Authority, not as penalty, but in liquidation of damages sustained. Award may then be made to the next lowest responsible bidder, or the work may be readvertised, or otherwise, as the Awarding Authority may decide.

If the bidder to whom the award is made is a corporation organized under the laws of a State other than Illinois, the bidder shall furnish the Awarding Authority a copy of the corporation's Certificate of Authority to do business in the State of Illinois with the return of the contract bond. Failure to furnish such evidence of a Certificate of Authority within the time required will be considered as just cause for the annulment of the award and the forfeiture of the proposal guaranty to the Awarding Authority, not as a penalty, but in payment of liquidated damages sustained as a result of such failure.

Failure to Execute the Acceptance of Proposal to Furnish Material. If the acceptance of proposal to furnish material is not executed by the Awarding Authority within 15 days following receipt from the bidder of the properly executed bonds, the bidder shall have the right to withdraw his/her bid without penalty.”

CHECK SHEET #LRS11

State of Illinois
Department of Transportation
Bureau of Local Roads and Streets

**SPECIAL PROVISION
FOR
EMPLOYMENT PRACTICES**

Effective: January 1, 1999

In addition to all other labor requirements set forth in this proposal and in the Standard Specifications for Road and Bridge Construction, adopted by the Department of Transportation, during the performance of this contract, the Contractor for itself, its assignees, and successors in interest (hereinafter referred to as the "Contractor") agrees as follows:

Selection of Labor. The Contractor shall comply with all Illinois statutes pertaining to the selection of labor.

Equal Employment Opportunity. During the performance of this contract, the Contractor agrees as follows:

- (a) That it will not discriminate against any employee or applicant for employment because of race, color, religion, sex, national origin, ancestry, age, marital status, physical or mental handicap or unfavorable discharge from military service, and further that it will examine all job classifications to determine if minority persons or women are underutilized and will take appropriate affirmative action to rectify any such underutilization.
- (b) That, if it hires additional employees in order to perform this contract or any portion hereof, it will determine the availability of minorities and women in the area(s) from which it may reasonably recruit and it will hire for each job classification for which employees are hired in such a way that minorities and women are not underutilized.
- (c) That, in all solicitations or advertisements for employees placed by it or on its behalf, it will state that all applicants will be afforded equal opportunity without discrimination because of race, color, religion, sex, national origin, ancestry, age, marital status, physical or mental handicap or unfavorable discharge from military service.

That it will send to each labor organization or representative of workers with which it has or is bound by collective bargaining or other agreement or understanding, a notice advising such labor organization or representative of the Contractor's obligations under the Illinois Human Rights Act and the Department's Rules and Regulations. If any such labor organization or representative fails or refuses to cooperate with the Contractor in its efforts to comply with so such Act and Rules and Regulations, the Contractor will promptly so notify the Illinois Department of Human Rights and the contracting agency and will recruit employees from other sources when necessary to fulfill its obligations thereunder.

CHECK SHEET #LRS11

- (e) That it will submit reports as required by the Department of Human Rights Rules and Regulations, furnish all relevant information as may from time to time be requested by the Department or the contracting agency, and in all respects comply with the Illinois Human Rights Act and the Department's Rules and Regulations.
- (f) That it will permit access to all relevant books, records, accounts and work sites by personnel of the contracting agency Illinois Department of Human Rights for purposes of investigation to ascertain compliance with the Illinois Human Rights Act and the Department's Rules and Regulations.
- (g) That it will include verbatim or by reference the provisions of this clause in every subcontract so that such provisions will be binding upon every such subcontractor. In the same manner as with other provisions of this contract, the Contractor will be liable for compliance with applicable provisions of this clause by all its subcontractors; and further it will promptly notify the contracting agency and the Illinois Department of Human Rights in the event any subcontractor fails or refuses to comply therewith. In addition, the Contractor will not utilize any subcontractor declared by the subcontracts with the State of Illinois or any of its political subdivisions or municipal corporations.

CHECK SHEET #LRS13

State of Illinois
Department of Transportation
Bureau of Local Roads and Streets

**SPECIAL PROVISION
FOR
SELECTION OF LABOR**

Effective: January 1, 1999
Revised: January 1, 2012

The Contractor shall comply with all Illinois statutes pertaining to the selection of labor.

Employment of Illinois Workers During Periods of Excessive Unemployment. Whenever there is a period of excessive unemployment in Illinois, which is defined herein as any month immediately following two consecutive calendar months during which the level of unemployment in the State of Illinois has exceeded five percent as measured by the United States Bureau of Labor Statistics in its monthly publication of employment and unemployment figures, the Contractor shall employ at least 90 percent Illinois laborers. "Illinois laborer" means any person who has resided in Illinois for at least 30 days and intends to become or remain an Illinois resident.

Other laborers may be used when Illinois laborers as defined herein are not available, or are incapable of performing the particular type of work involved, if so certified by the Contractor and approved by the Engineer. The Contractor may place no more than three of his regularly employed non-resident executive and technical experts, who do not qualify as Illinois laborers, to do work encompassed by this Contract during a period of excessive unemployment.

This provision applies to all labor, whether skilled, semi-skilled or unskilled, whether manual or non-manual.

CHECK SHEET #LRS15

State of Illinois
Department of Transportation

**SPECIAL PROVISION
FOR
PARTIAL PAYMENTS**

Effective: January 1, 2007

Add the following after the first paragraph of Article 109.07(a) of the Standard Specifications:

“The State will deduct from the amount so determined for the first 50 percent of the completed work a sum of ten percent to be retained until after the completion of the entire work to the satisfaction of the Engineer. After 50 percent or more of the work is completed, the Engineer may, at his/her discretion, certify the remaining partial payments without any further retention, provided that satisfactory progress is being made, and provided that the amount retained is not less than five percent of the total adjusted contract price. When the principal items of the work have been satisfactorily completed, a semi-final estimate may be made with the consent of the surety. Payment to the Contractor under such an estimate shall not exceed 90 percent of the amount retained after making partial payments, but in no event shall the amount retained after making the semi-final payment be less than one percent of the adjusted contract price, nor less than \$500.00.

When any payment is made directly to the State, payments for completed work shall have deducted the proportionate share of the cost to be borne by the State. The deduction will be the estimated cost to the State divided by the awarded contract value with this percentage applied to the value of work in place. Any adjustment to be made because of changed quantities will be made when the final payment is being processed. No retainage will be held from the value of such payments.”

Completion Date
August 1, 2024

SUNBURY TOWNSHIP

LIVINGSTON COUNTY
T.30N.-R.5E.-3rd. P.M.

24-28121-00-AS
5,330 TON AGG.SURF.CSE., TYB
FURN., DEL., TO JOBSITE
MFT & LOCAL FUNDS

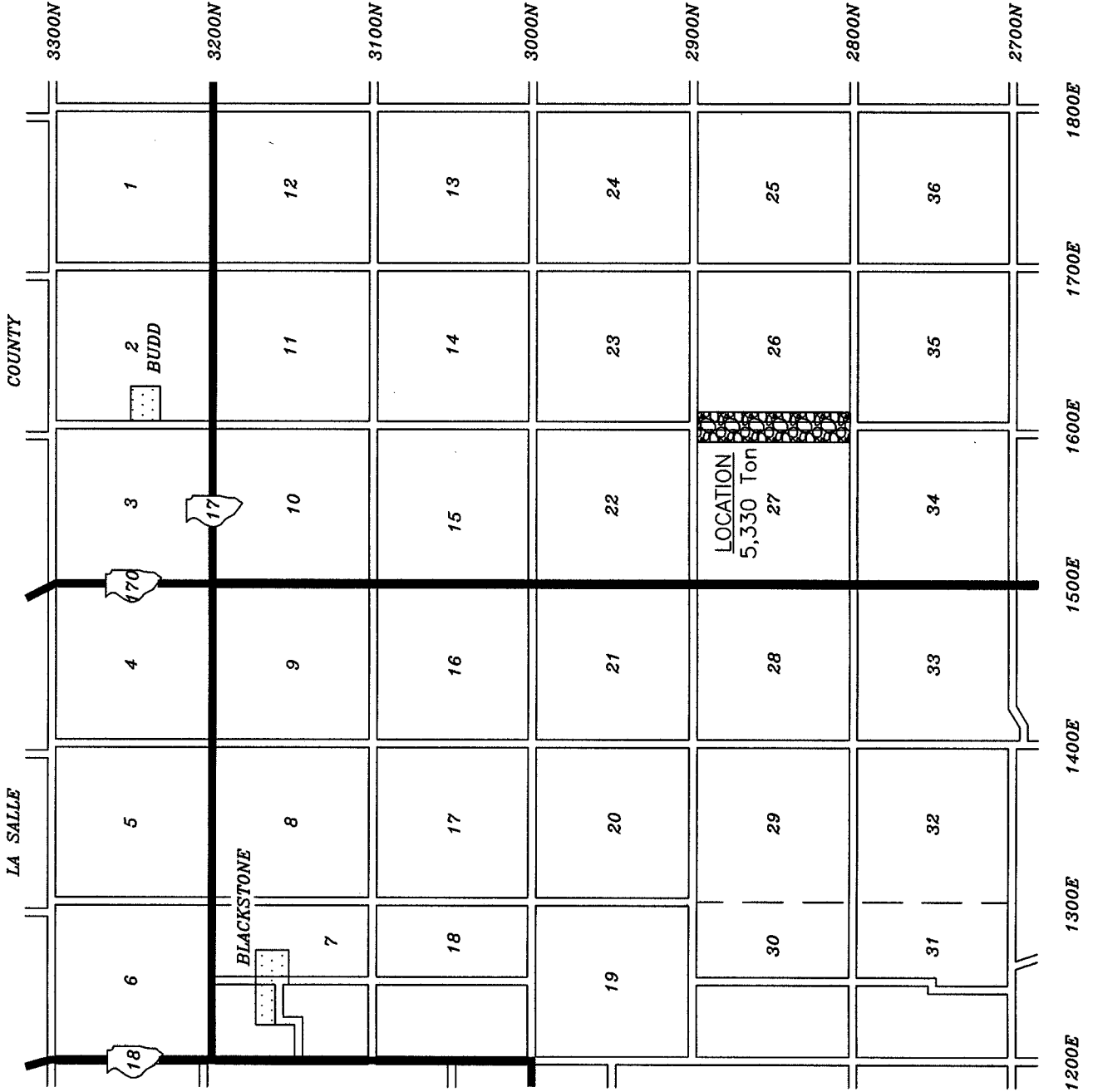

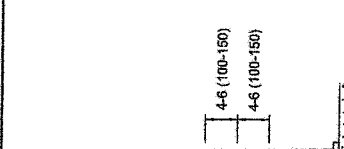

DRUM

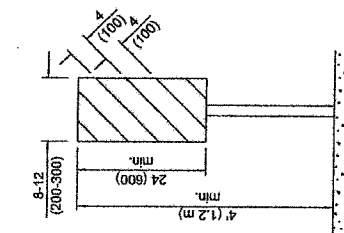

**VERTICAL PANEL
POST MOUNTED**

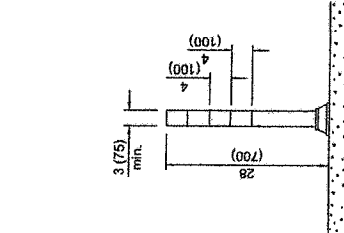

TUBULAR MARKER

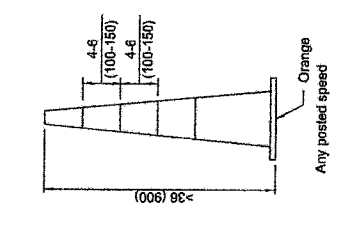

DAY OR NIGHTTIME USE

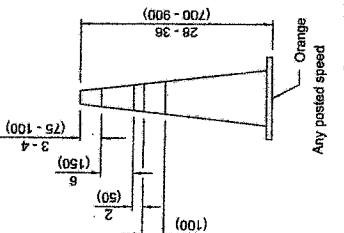

CONES

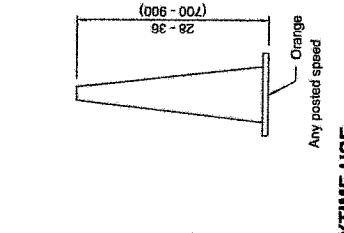

DAYTIME USE

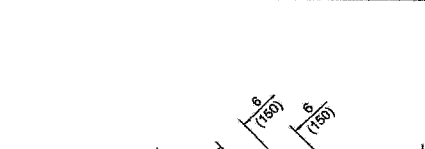

TYPE III BARRICADE

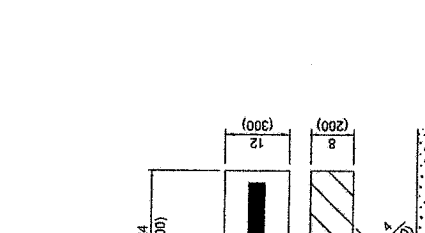

**DIRECTION INDICATOR
BARRICADE**

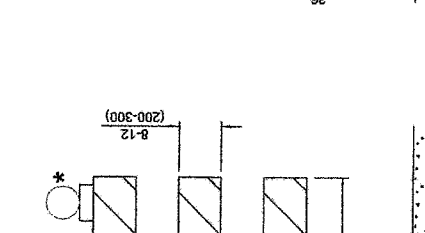

TYPE II BARRICADE

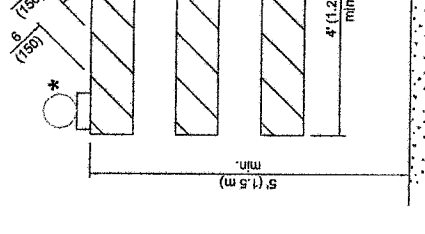

TYPE I BARRICADE

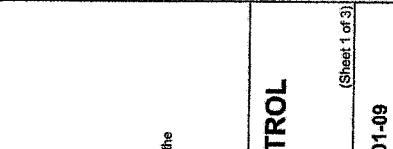

**DETECTABLE PEDESTRIAN
CHANNELIZING BARRICADE**

* Warning lights (if required)

GENERAL NOTES

All heights shown shall be measured above the pavement surface.

All dimensions are in inches (millimeters) unless otherwise shown.

DATE	REVISIONS
1-1-24	Revised Type III Barricade notes (sht. 3) & moved warning light on post mounted signs to top center.
1-1-19	Revised cones usage and added cones > 36" (900 mm) height.

**TRAFFIC CONTROL
DEVICES**

(Sheet 1 of 3)

STANDARD 701901-09

Illinois Department of Transportation
 APPROVED: [Signature] 2024
 ENGINEER OF SAFETY PROGRAM ENGINEERING
 APPROVED: [Signature] 2024
 ENGINEER OF DESIGN AND ENVIRONMENT
 ISSUED 1-1-13

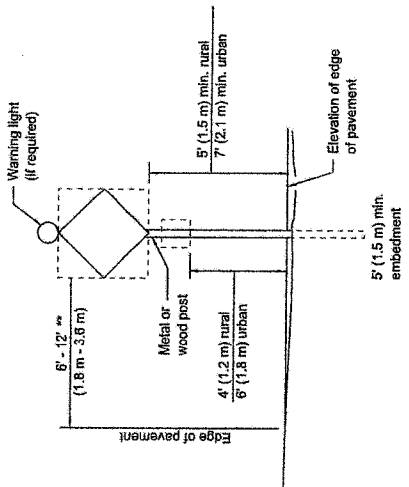

POST MOUNTED SIGNS
 ** When curb or paved shoulder are present this dimension shall be 24 (600) to the face of curb or 6' (1.8 m) to the outside edge of the paved shoulder.

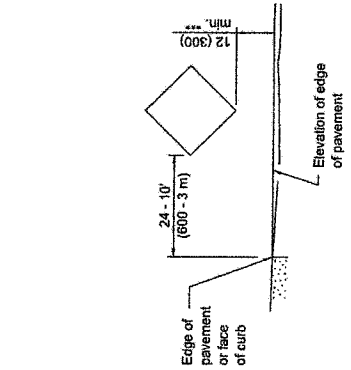

SIGNS ON TEMPORARY SUPPORTS
 *** When work operations exceed four days, this dimension shall be 5' (1.5 m) min. If located behind other devices, the height shall be sufficient to be seen completely above the devices.

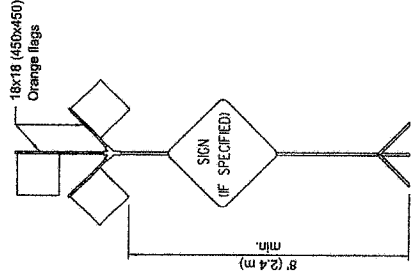

HIGH LEVEL WARNING DEVICE

ROAD CONSTRUCTION NEXT X MILES
 G20-1104(0)-6036

END CONSTRUCTION
 G20-1105(0)-6024

This signing is required for all projects (3200 m) or more in length.
 ROAD CONSTRUCTION NEXT X MILES sign shall be placed 500' (150 m) in advance of project limits.
 END CONSTRUCTION sign shall be erected at the end of the job unless another job is within 2 miles (3200 m).
 Dual sign displays shall be utilized on multi-lane highways.

WORK LIMIT SIGNING

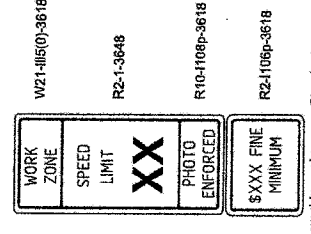

Sign assembly as shown on Standards or as allowed by District Operations.

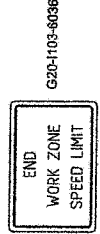

This sign shall be used when the above sign assembly is used.

HIGHWAY CONSTRUCTION SPEED ZONE SIGNS

**** R 10-1106p shall only be used along roadways under the jurisdiction of the State.

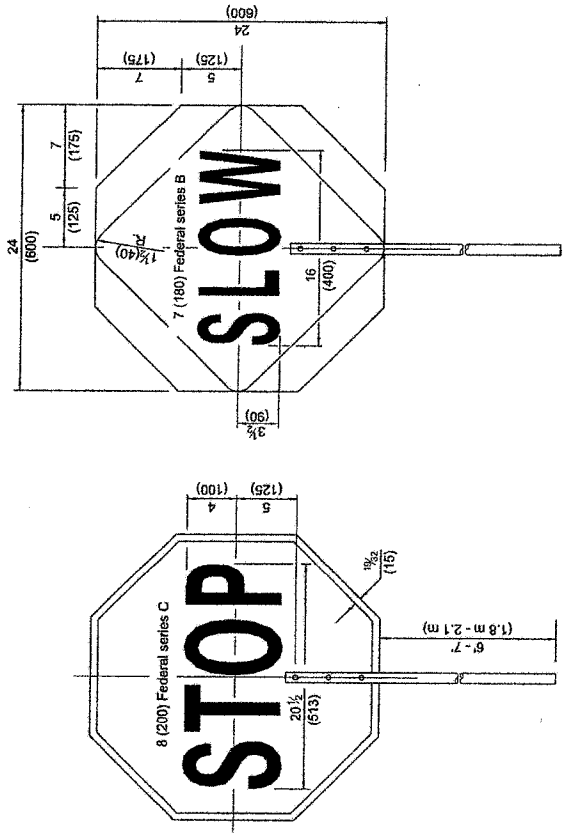

FRONT SIDE REVERSE SIDE

FLAGGER TRAFFIC CONTROL SIGN

Illinois Department of Transportation

APPROVED: *[Signature]* 2024
 ENGINEER OF SAFETY FACILITIES AND ENGINEERING

APPROVED: *[Signature]* 2024
 ENGINEER OF DESIGN AND ENVIRONMENT

ISSUED 1-1-13

TRAFFIC CONTROL DEVICES

STANDARD 701901-09 (Sheet 2 of 3)

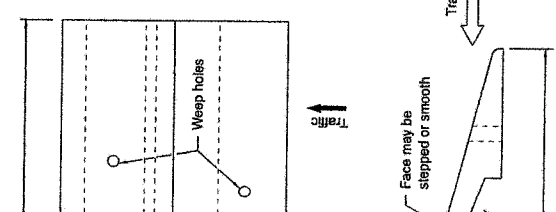
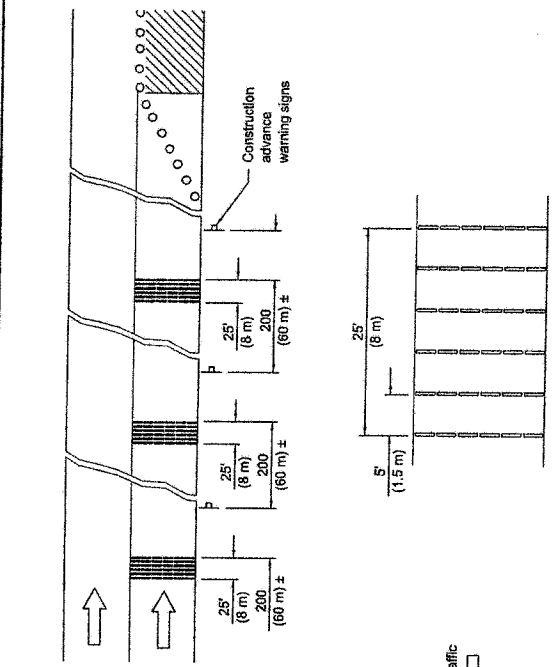

TYPICAL INSTALLATION

TEMPORARY RUMBLE STRIPS

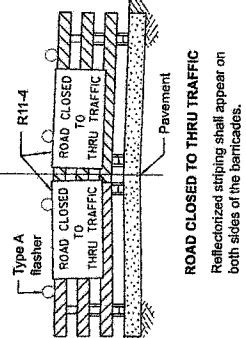
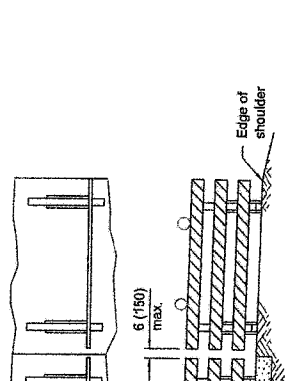
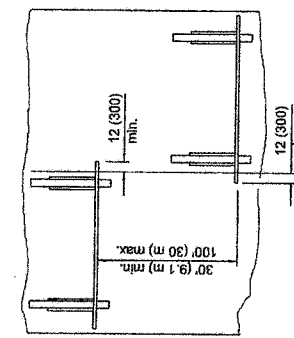

ROAD CLOSED TO THRU TRAFFIC
ReflectORIZED striping shall appear on both sides of the barricades.

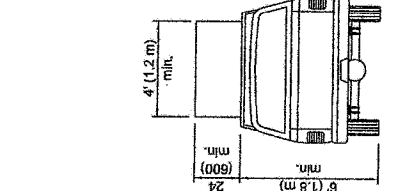
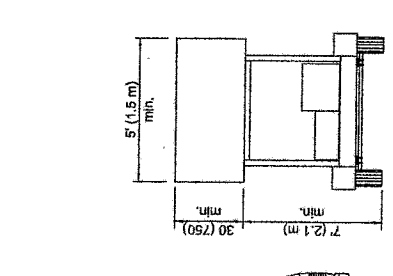
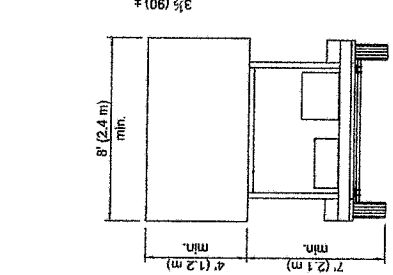
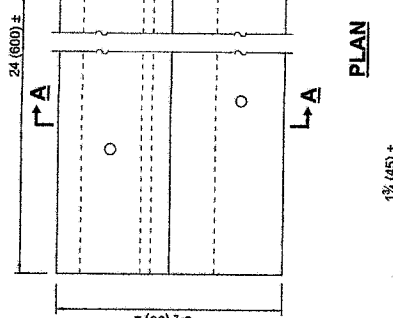

TYPE C TRAILER MOUNTED

TYPE B ROOF OR TRAILER MOUNTED

TYPE A ROOF MOUNTED

ARROW BOARDS

SECTION A-A

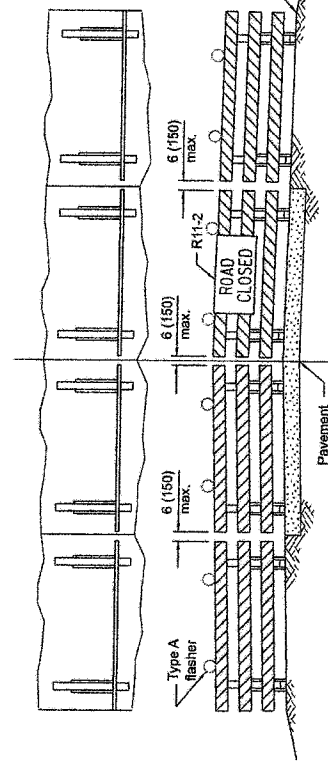

ROAD CLOSED TO ALL TRAFFIC
ReflectORIZED striping may be omitted on the back side of the barricades.

TRAFFIC CONTROL DEVICES

STANDARD 701901-09

(Sheet 3 of 3)

TYPICAL APPLICATIONS OF TYPE III BARRICADES CLOSING A ROAD

If a Type III barricade with an attached sign panel which meets NCHRP 350 or MASH is not available, this sign may be mounted on an NCHRP 350 or MASH temporary sign support directly in front of the barricade.

Illinois Department of Transportation APPROVED: <i>[Signature]</i> ENGINEER OF SAFETY TRAFFIC AND ENGINEERING APPROVED: <i>[Signature]</i> ENGINEER OF DESIGN AND ENVIRONMENT	ISSUED 1-1-13 2024 2024
---	-------------------------------

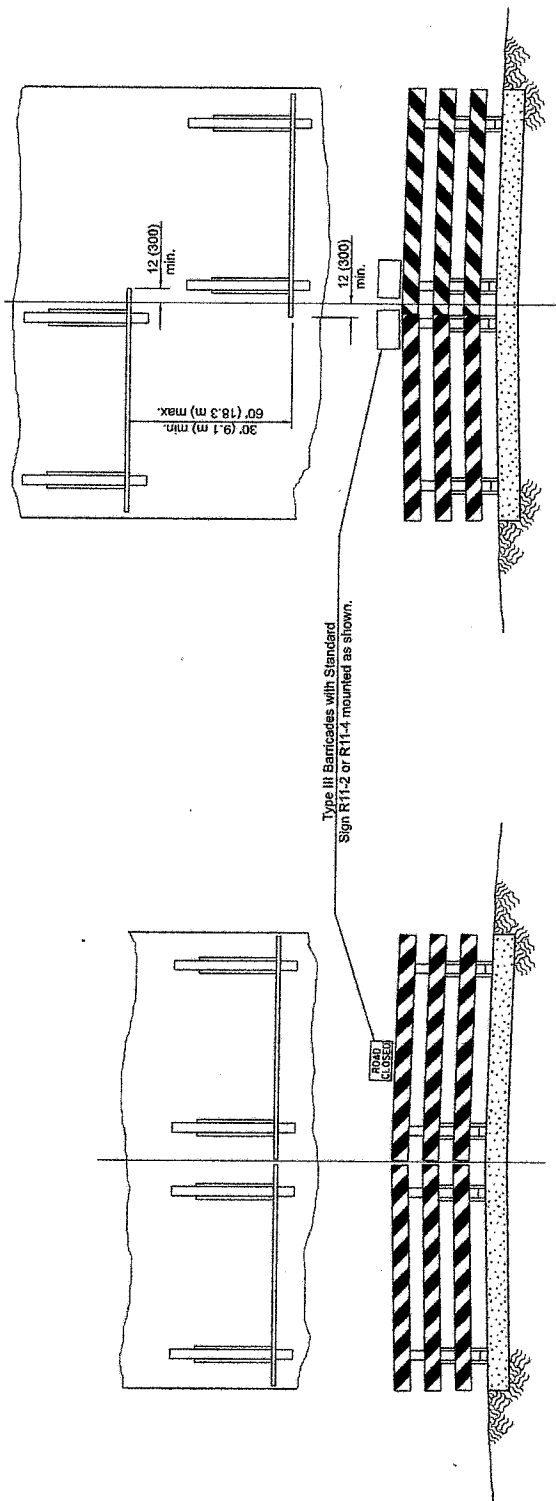

Type III Barricades with Standard Sign R11-2 or R11-4 mounted as shown.

Resident traffic and day labor force's equipment to use road shoulder for passing barricades.

Use when shoulders are too narrow for passage of traffic.

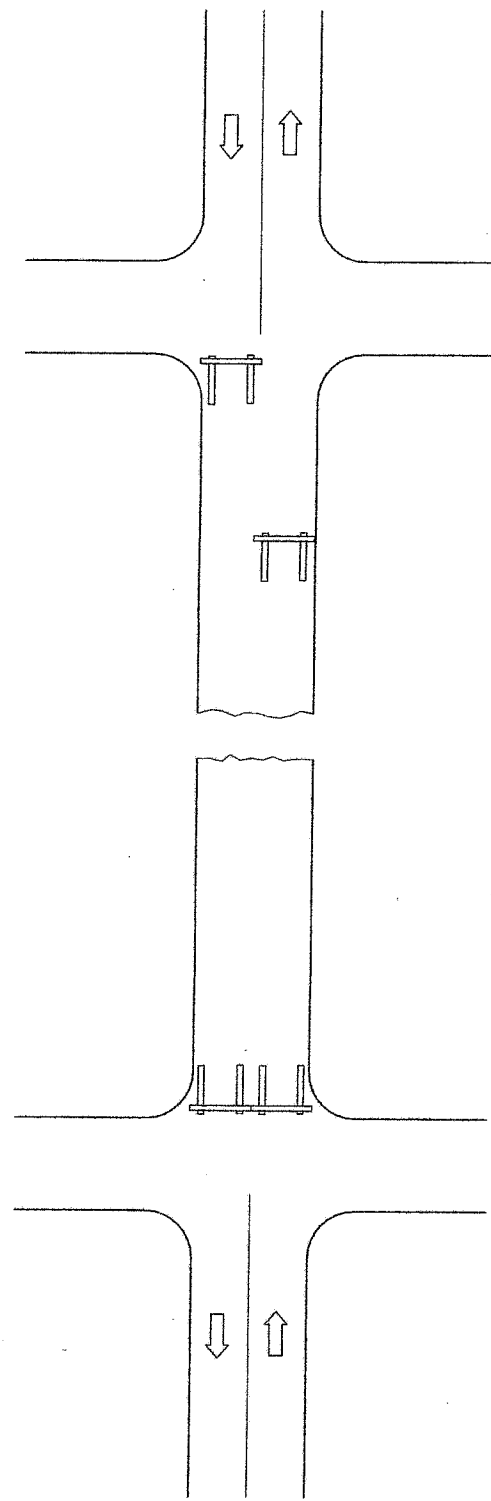

TWO-LANE, TWO-WAY TRAFFIC, RURAL OPERATIONS EXCEEDING ONE DAYLIGHT PERIOD

GENERAL NOTES

Type III barricades to be width of pavement only.
 Reflectized striping shall appear on both sides of barricades. Barricades shall be positioned so that stripes slope downward toward the side on which traffic is to pass.
 Although not shown, advance warning signs with minimum dimensions of 36x36 (900x900) and black legends on orange reflectized backgrounds shall be utilized where needed.
 This case is for use on rural local roads where the local authority considers this protection to be appropriate for the specific job conditions.
 All dimensions are in inches (millimeters) unless otherwise shown.

Illinois Department of Transportation		ISSUED 1-1-87	
APPROVED	GROUP 1	2008	
ENGINEER OF LOCAL ROADS AND STREETS			
APPROVED	GROUP 1	2008	
ENGINEER OF DESIGN AND ENVIRONMENT			

DATE	REVISIONS
1-1-09	Switched units to English (metric)
1-1-98	Rev. "R-11-1" to "R11-4", Rev. 4th General Note.

TRAFFIC CONTROL DEVICES - DAY LABOR CONSTRUCTION

STANDARD B.L.R. 17-4

COUNTY LIVINGSTON

RD DIST. SUNBURY

SECTION 24-28121-00-AS

MFT & LOCAL FUNDS

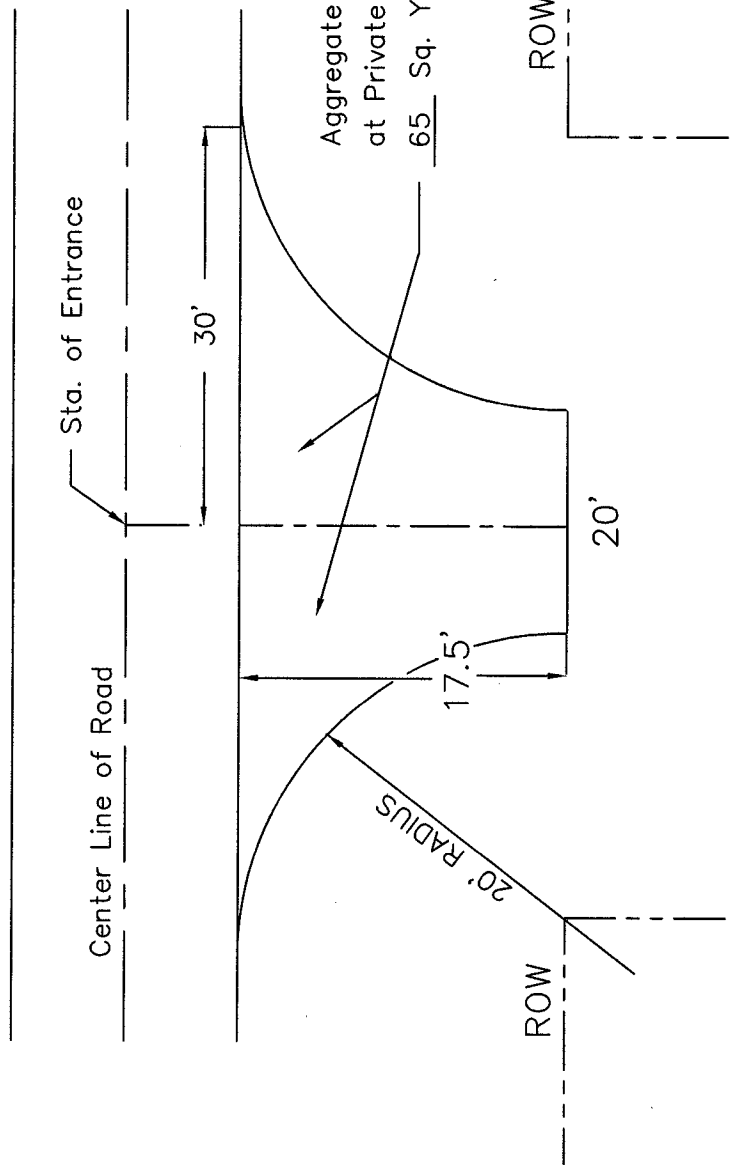

PRIVATE ENTRANCES

Loc.	Sta.	Side	SQ YD	Ton
1	30+59	RT	65	33
1	30+84	LT	65	33
1	31+90	LT	65	33
				<u>99</u>

T30N. R5E. OF THE 3rd PM

SEC. 27

SECTION	COUNTY	TWP OR RD DIST	SHEET NO.
24-28121-00-AS	LIVINGSTON	SUNBURY	1 OF 1

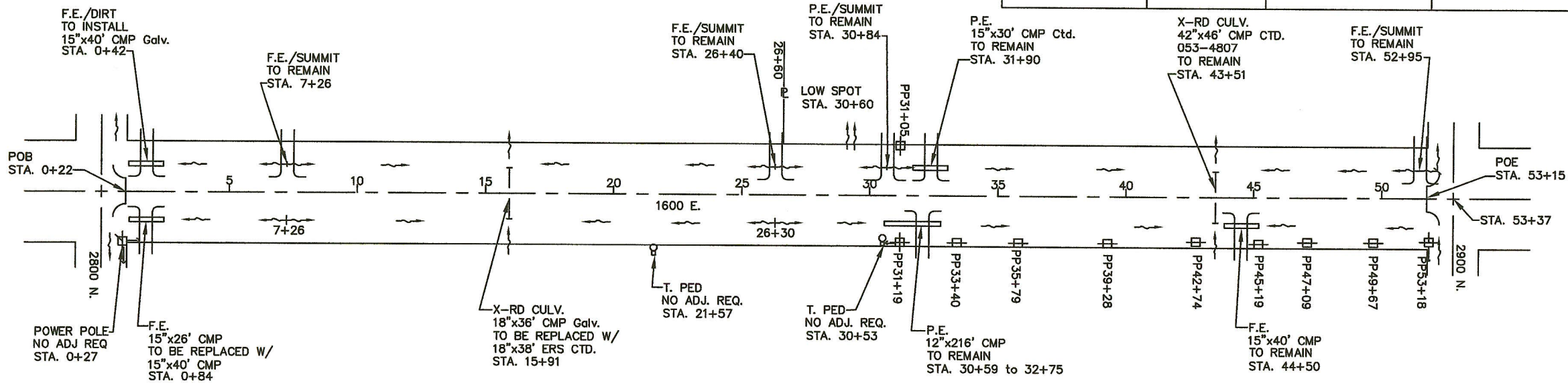

NOTE: ALL CROSS ROAD CULVERTS
CROWN ELEV. = 100.0
FLOWLINE ELEV. = 96.5
SLOPE MIN. = 0.4%

SEC. 26

NOTE: NO ADJUSTMENT REQUIRED
FOR POWER POLES

	R.O.W. WIDTH	EXIST. PROP.
	55'	55'
	ROADWAY WIDTH	22' 24'
	PAVEMENT WIDTH	18' 20'

